

OLYMPUS[®]

Your Vision, Our Future

OES HYSTEROFIBERSCOPE

HYF-XP

Ultra-Slim 3.1 mm Insertion Tube Enables Intra-Uterine Observation on an Outpatient Basis



Office Diagnostic Hysteroscopy is Easy and Convenient.

Introducing the OES Hysteroscope Olympus HYF-XP

With Ultra-Slim 3.1 mm Insertion Tube and Wider, Brighter, Clearer Imaging.

The HYF-XP 3.1 mm minimally invasive flexible hysteroscope from Olympus offers exceptional imaging capability, flexibility, and enhanced patient comfort. With an insertion tube diameter of only 3.1 mm, the flexible HYF-XP is the slimmest hysteroscope in its class, enabling easy, safe insertion without cervical dilation or anesthesia. More importantly, the advanced lens and fiber technologies incorporated in the HYF-XP have made possible a larger field of view and exceptional image resolution for easier, observation of intrauterine pathology. When it comes to safe examinations, the choice has never been clearer:

The OES Hysteroscope HYF-XP from Olympus.

Bigger, Clearer Imaging

With a diameter 1.3 times larger than our previous models and a clearer, more detailed picture, the HYF-XP's lens not only provides doctors with an unobstructed view for observing intrauterine pathology, it may reduce eye fatigue.

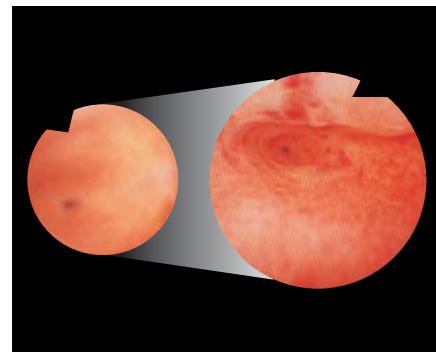

Newly Developed Optical Diagnostic System

Ultra-Slim 3.1 mm Insertion Tube

With an insertion tube diameter of only 3.1 mm, the HYF-XP can be inserted safely into the endocervical canal without anesthesia or cervical dilation, which may minimize patient discomfort and trauma, and allowing efficient, immediate examinations on an outpatient basis.



Exceptional Resolution and Brightness

The proprietary design of the optical system provides exceptional image resolution and brightness. Tissue pathology details become more identifiable and natural looking.

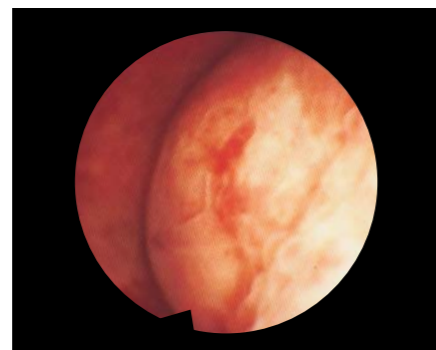

Wider Field of View for Observation of Both Tubal Ostia

With its 100° wide field of view, the HYF-XP lets one easily view both tubal ostia simultaneously, which may enable one to perform procedures more efficiently.

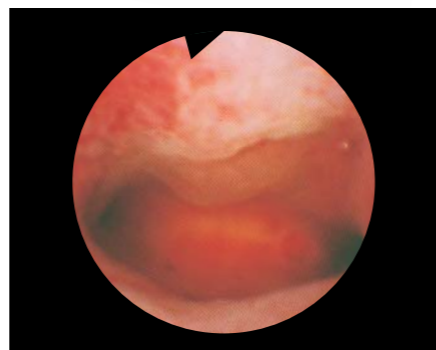

Optimized Design for Greater Flexibility and Smoother Insertion

Optimized Flexibility for Smoother Insertion and Maneuvering

This scope inserts smoothly and easily. Even when the uterus is swollen by disease, the scope can be passed easily through the cervical canal without traumatizing the tissue.

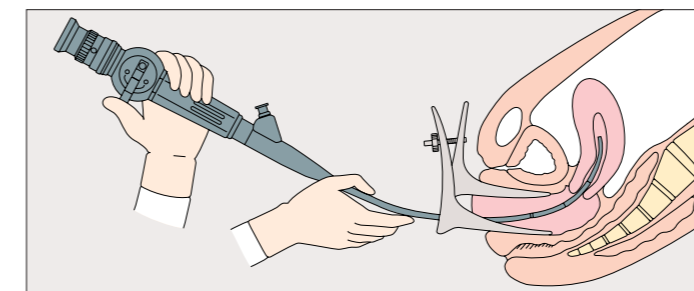

Easy One-Handed Operation

The exclusive, Olympus-developed solid rubber pad on the grip responds instantly to tactile pressure, moving the insertion tube in response to your every move - back and forth, up and down, or twisting.

Wide Short-Scale Angulation Range of 100° Up and Down

With its wide, short-scale angulation range, the HYF-XP can be maneuvered within the narrow confines of the uterus.

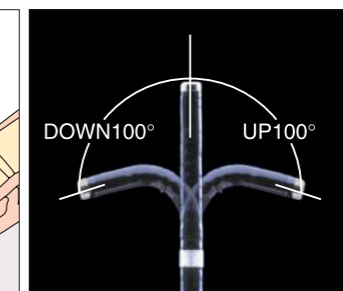

Standard Eyepiece

Designed for easy integration into existing video systems, the HYF-XP features a standard eyepiece that allows it to be combined with a wide range of ancillary equipment. There's no need to replace or upgrade the equipment you already have.



System Chart

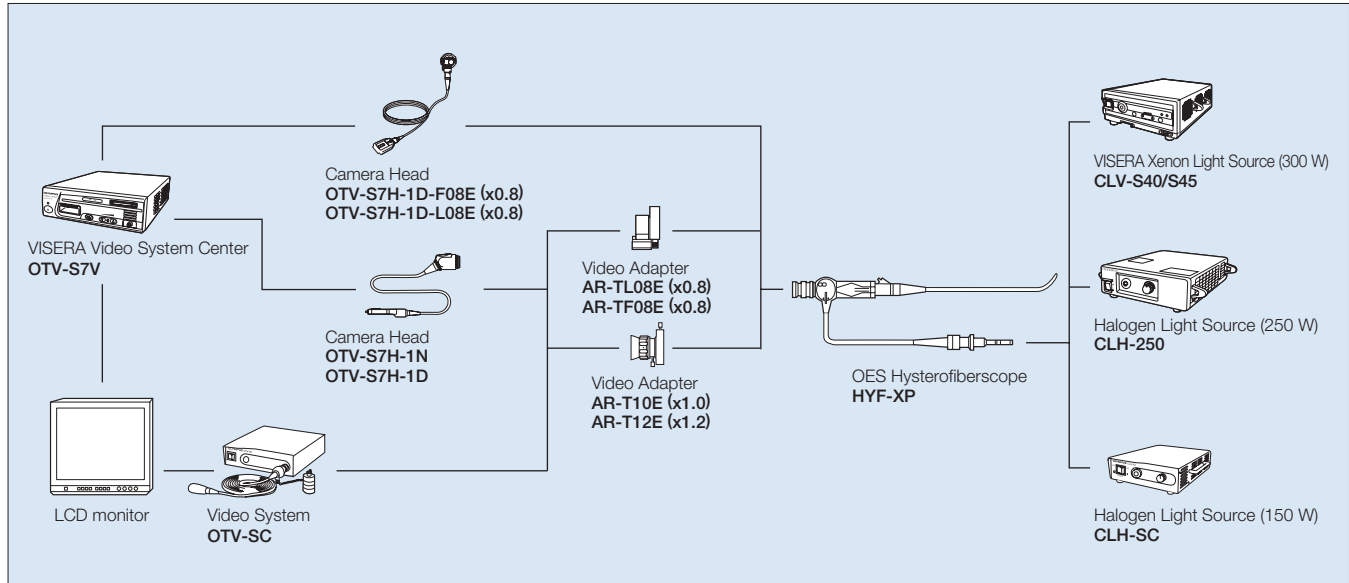

Specifications

Optical System	Field of View	100°
	Direction of View	Forward viewing
	Depth of Field	2 - 50 mm
Insertion Portion	Distal End Outer Diameter	3 mm
	Insertion Tube Outer Diameter	3.1 mm
	Working Length	240 mm
Instrument Channel	Channel Inner Diameter	1.2 mm
Bending Section	Angulation Range	Up 100° / Down 100°
Total Length		540 mm

Standard Set

- OES HYSTEROFIBERSCOPE OLYMPUS HYF TYPE XP
- BW-7B Channel Cleaning Brush
- BW-15SH Channel Cleaning Brush
- MB-156 ETO Cap
- MH-507 Channel-Opening Cleaning Brush

Products



VISERA Video System

The VISERA Video System includes high-resolution videoscopes and autoclavable camera heads/ videolaparoscopes, and can be used for endoscopic procedures, whether in the office or operating room. Still/moving image recording is digital, making application and management of recorded images smoother than ever.



OTV-SC Video System

With its high-performance CCD, this system delivers superb imaging quality. An electronic shutter ensures that the optimal amount of light is supplied at all times.

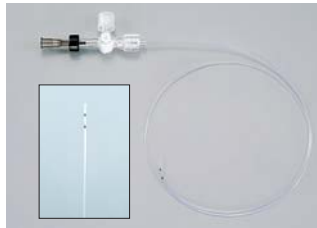

PR-22SV Disposable Cannula

Integrates the T-plug and cannula tube into one convenient unit and features a specially designed tip that permits easy insertion without damaging the uterine wall or endometrium, to enable smooth salpingography.



HYF-1T OES HysteroFiberscope

Compatible with biopsy/grasping forceps, HYF-1T is less invasive and leads to quicker patient recovery.

Specifications, design and accessories are subject to change without any notice or obligation on the part of the manufacturer.

OLYMPUS[®]

OLYMPUS MEDICAL SYSTEMS CORP.
Shinjuku Monolith, 2-3-1 Nishi-Shinjuku, Shinjuku-ku, Tokyo 163-0914, Japan

For a complete listing of sales and distribution locations visit www.olympus.com