

HAND INSTRUMENTS

HICURA, HiQ+

A Wide Range for Laparoscopic Surgery





Safety and Comfort in Laparoscopic Surgery

Contents

HICURA – the next step	4
HICURA bipolar – safe and reliable	6
HICURA kits – the most popular choice	8
Sterilization tray	10
Suction and irrigation	12
Needle holders	13
5 mm HICURA grasping forceps	14
5 mm HICURA dissection forceps	19
5 mm HICURA monopolar scissors	21
5 mm HICURA knot pusher and assistant needle holder ...	22
5 mm HICURA biopsy forceps	23
5 mm HICURA bipolar grasping forceps	24
5 mm HICURA bipolar dissection forceps	25
Modular spare parts for 5 mm HICURA instruments	26
HICURA system charts	27
10 mm HiQ+ hand instruments	28
HiQ+ spare parts for 10 mm instruments	31
5 mm HiQ+ monopolar HF electrodes	32
HiQ+ suction and irrigation	33
HiQ+ needle holder	35
HiQ+ knot pusher and fascial closure	37

HICURA – the Next Step

Monopolar and standard hand instruments

HICURA is the new generation of laparoscopic hand instruments that follows the HiQ+ line. HICURA offers a modular system comprising a wide range of product offerings with different lengths, shafts, handles, and jaws to accommodate surgeons' needs. The three-part design enables individual replacement of worn components. The system contains no spare parts that might get lost which turns HICURA into a smart solution for every OR.

High quality and high performance – HICURA

HICURA was developed with the aim of improving the instruments' handling and safety. HICURA is designed for customers' comfort and usability during surgery, allowing multiple hand positions for constantly changing surgical requirements.



Features

- Intuitive and easy assembly and disassembly thanks to acoustic “click” feedback
- HICURA hand instruments 250mm and 330mm can be sterilized in assembled configuration
- Adapted handle design for grasping and dissection forceps
- Modular, exchangeable and cost-effective system
- Ergonomic Size M and Size L handles available



Different hands – different needs

HICURA offers two different handle sizes: Size M for small to medium hands, and Size L for medium to large hands. HICURA handles are designed to enhance usability and user comfort during laparoscopy. Depending on preferences and the area of application, handles with ratchet, deactivatable ratchet, or no ratchet are available.



Adapted jaw mechanism

The two dedicated joint mechanisms (CAM and SL) give surgeons adapted tissue control during grasping and dissection. The CAM grasping mechanism and the SL dissection mechanism offer optimized tissue manipulation: The CAM mechanism provides higher grasping forces and is therefore designed for firm grasping, whereas the SL mechanism is designed for optimized dissection because the jaws open at a wider angle.



Assembly and disassembly have never been easier – just click it!

HICURA's modular system allows intuitive and easy assembly in just three steps. Acoustic feedback confirms that the instrument has been correctly assembled.



Rotation knob

The new design of the rotation knob allows easy and precise rotation of the jaws insert: Rotation with low resistance when the jaws are open, retarded rotation when tissue is firmly grasped.

HICURA Bipolar – Safe and Reliable

HICURA bipolar instruments have a special joint design which allows strong grasping and precise dissection, just like their monopolar counterparts. Furthermore, safe and reliable bipolar coagulation is possible, even in challenging situations. HICURA bipolar instruments thus combine monopolar mechanical characteristics with safe bipolar coagulation.



Features

- HICURA hand instruments 250mm and 330mm can be sterilized in assembled configuration
- White color coding for clear identification of bipolar instruments
- Safe HF application with bipolar energy
- Robust PEEK insulation of the shaft
- Modular three-part system



Color coding for clear instrument identification

HICURA bipolar hand instruments are color-coded on the handle and the rotation wheel. The inserts also have a white insulation, so this allows rapid identification of all the bipolar components.



Excellent jaw insulation

The bipolar jaws are PFA-insulated, thus reducing the risk of coagulation failures. The design of HICURA bipolar instruments allows strong grasping and effective coagulation, thereby combining monopolar mechanical strengths with bipolar coagulation.



Safety first

HICURA shafts are PEEK insulated in order to provide optimized stability, durability and electrical insulation.

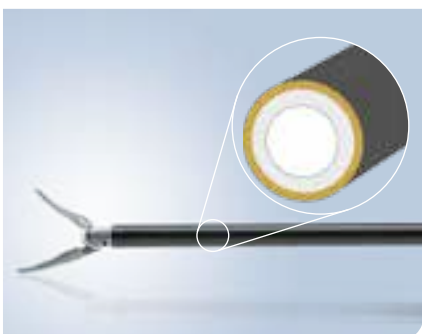

HICURA Kits – the Most Popular Choice

HICURA offers a huge variety of modular parts. There are eight different-sized handles, four shafts, and more than forty different jaw inserts which are available in different lengths. Depending on the surgeon's preferences and the procedure that's being performed, basic instrumentation kits can be recommended for every area of application.

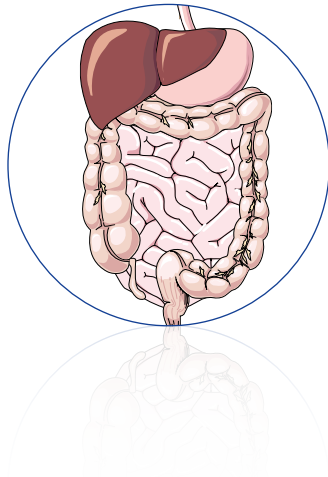

Kit for general surgery

The general surgery kit includes those hand instruments which are most useful in standard laparoscopic procedures such as cholecystectomy, hernia repair or appendectomy.

- Johann, Clinching, Johann single action, and Croce-Olmi grasping forceps
- Maryland dissection forceps
- Metzenbaum scissors



Johann



Clinching



Johann single action



Croce-Olmi



Maryland



Metzenbaum

Extension kit for general surgery

The extension kit for general surgery is useful for colon surgery and fundoplication.

- Babcock, Johann long, and atraumatic grasping forceps
- Maryland long dissection forceps
- Needle holder
- Hook scissors



Babcock



Johann long



Atraumatic



Maryland long



Needle holder



Hook scissors

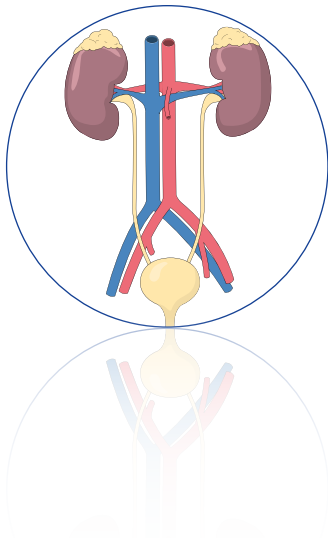

Kit for urology

The laparoscopic urology kit contains several bipolar instruments, and can—for example—be used for nephrectomies and adrenalectomies.

- Johann and Hirsch bipolar grasping forceps
- Monopolar grasping forceps with lumen
- Maryland bipolar dissection forceps
- Maryland monopolar dissection forceps, 90° angled
- Monopolar Metzenbaum scissors



Bipolar Johann



Bipolar Hirsch



Monopolar Metzenbaum



Monopolar with lumen



Bipolar Maryland



Monopolar Maryland, 90°

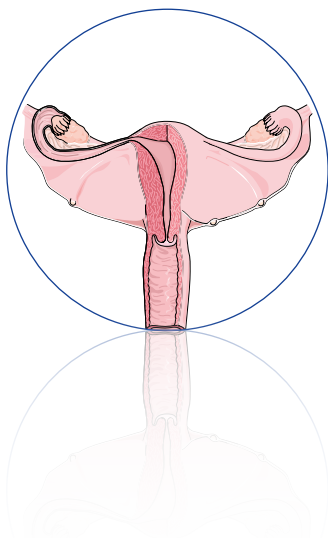

Kit for gynecology

The gynecology kit includes hand instruments that are helpful for laparoscopic procedures such as hysterectomies or cystectomies.

- Johann, Hirsch, and Manhes bipolar grasping forceps
- Monopolar grasping forceps with lumen
- Maryland bipolar dissection forceps
- Monopolar Metzenbaum scissors



Bipolar Johann



Bipolar Hirsch



Bipolar Manhes



Monopolar with lumen



Bipolar Maryland



Monopolar Metzenbaum

Sterilization Tray

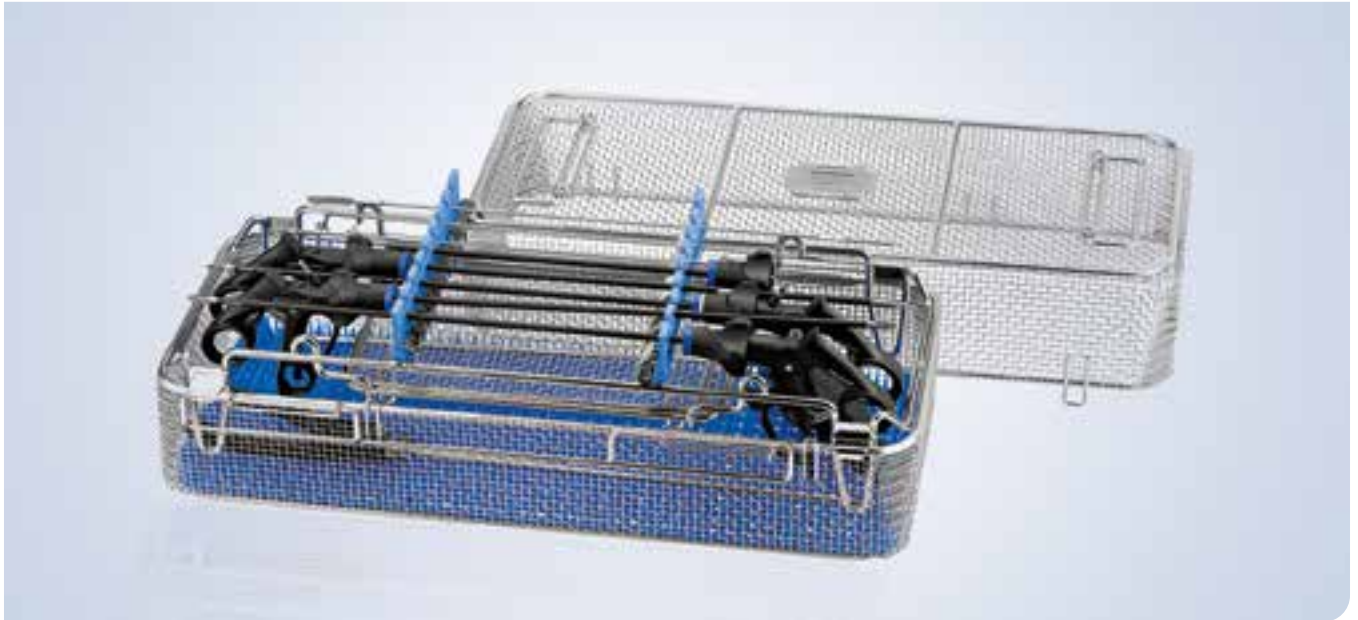

- Compatible with standard container systems or soft packaging thanks to durable wire mesh of lid and instrument basket



- Storage and sterilization of disassembled and assembled laparoscopic hand instruments



- Minimal contact between the instrument and the retainer while allowing secure immobilization of different instrument diameters



- Blue silicone components (retainer, mat) can be individually replaced

Instrument Basket System

WA05956A Instrument basket system,
for HiQ+, HICURA

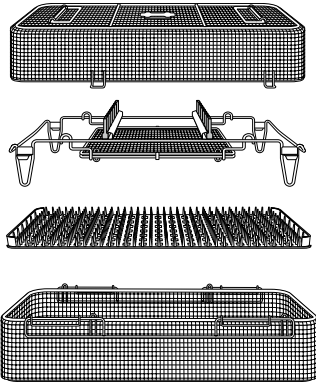

WA05957A Spare retainer,
silicone,
set, 2 pcs.,
for WA05956A

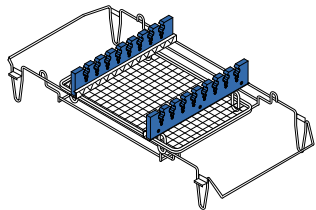

WA05958A Spare mat,
nubby,
silicone,
for WA05956A



Suction and Irrigation



Clog-free operation

The HiQ+ suction/irrigation system is optimized for streamlined flow throughout every component from inflow to outflow, thus enabling enhanced passage of immersed blood clots or stones.

The modular system with its range of suction/irrigation tubes offers tailor-made solutions for a variety of laparoscopic procedures and anatomies.

The HiQ+ suction/irrigation system combines excellent performance with surgeon-specific ergonomics and superior quality.



Customizable system

Olympus offers a wide range of suction/irrigation tubes for its HiQ+ system:

- Diameters of 3, 5 and 10 mm
- Working lengths of 360 and 450 mm
- Multiple tip designs, e.g. for harvesting lost gall bladder stones or aspirating hydrops



Optimized ergonomics

Economically designed handle for different irrigation needs:

- Active handle with fingertip lever to control suction/irrigation



Easy reprocessing

The HiQ+ suction/irrigation system is designed for easy assembly, disassembly and cleaning. All the components are easily detachable and autoclavable.

Needle Holders



Strong and durable

The HiQ+ needle holders and knot pushers are a series of instruments designed to meet the highest expectations of functionality, ergonomics, and reprocessing.



Strong and durable

The HiQ+ needle holders are engineered for:

- High grasping strength
- High accuracy to ensure precise and reliable control of the needle
- High durability, with hard-metal inlays in the jaws



Exchangable jaw inserts

The HiQ+ needle holder is available with five interchangeable jaws:

- Straight needle holder
- Left/right-curved needle holder
- Self-aligning needle holder
- Assistant needle holder
- Dolphin type needle holder

The modular design permits easy assembly, disassembly and cleaning. All parts are autoclavable.



Optimized ergonomics

The handle of the HiQ+ needle holder meets the highest ergonomic standards. Olympus engineers have worked closely with ergonomics experts to design a handle that will be “an extension of the surgeon's hand”.

5 mm HICURA Grasping Forceps

Johann Forceps

Multipurpose grasping forceps with large jaws and good visibility

Length of jaws: 21 mm



Article Number Description

WA69310M	Jaws insert "HICURA", 5 x 330, Johann, monopolar
WA69310S	Jaws insert "HICURA", 5 x 250, Johann, monopolar
WA69310L	Jaws insert "HICURA", 5 x 430, Johann, monopolar
WA69300M	Shaft "HICURA", 5 x 330, monopolar
WA69300S	Shaft "HICURA", 5 x 250, monopolar
WA69300L	Shaft "HICURA", 5 x 430, monopolar
WA69000M	Handle "HICURA", size M, deactivatable ratchet
WA69000L	Handle "HICURA", size L, deactivatable ratchet
WA69001M	Handle "HICURA", size M, monopolar
WA69001L	Handle "HICURA", size L, monopolar
WA69003M	Handle "HICURA", size M, ratchet
WA69003L	Handle "HICURA", size L, ratchet

Johann Single-Action Forceps

The single action mechanism offers improved handling in limited operating areas and allows atraumatic and firm grasping of tissue

Length of jaws: 24 mm



Article Number Description

WA69312M	Jaws insert "HICURA", 5 x 330, Johann, single action, monopolar
WA69312S	Jaws insert "HICURA", 5 x 250, Johann, single action, monopolar
WA69312L	Jaws insert "HICURA", 5 x 430, Johann, single action, monopolar
WA69300M	Shaft "HICURA", 5 x 330, monopolar
WA69300S	Shaft "HICURA", 5 x 250, monopolar
WA69300L	Shaft "HICURA", 5 x 430, monopolar
WA69000M	Handle "HICURA", size M, deactivatable ratchet
WA69000L	Handle "HICURA", size L, deactivatable ratchet
WA69001M	Handle "HICURA", size M, monopolar
WA69001L	Handle "HICURA", size L, monopolar
WA69003M	Handle "HICURA", size M, ratchet
WA69003L	Handle "HICURA", size L, ratchet

Long Johann Forceps

Longest jaws in the 5 mm line-up of HICURA hand instruments for atraumatic grasping of larger organs (e.g. colon)

Length of jaws: 40 mm



Article Number Description

WA69314M	Jaws insert "HICURA", 5 x 330, Johann long, monopolar
WA69314S	Jaws insert "HICURA", 5 x 250, Johann long, monopolar
WA69314L	Jaws insert "HICURA", 5 x 430, Johann long, monopolar
WA69300M	Shaft "HICURA", 5 x 330, monopolar
WA69300S	Shaft "HICURA", 5 x 250, monopolar
WA69300L	Shaft "HICURA", 5 x 430, monopolar
WA69000M	Handle "HICURA", size M, deactivatable ratchet
WA69000L	Handle "HICURA", size L, deactivatable ratchet
WA69001M	Handle "HICURA", size M, monopolar
WA69001L	Handle "HICURA", size L, monopolar
WA69003M	Handle "HICURA", size M, ratchet
WA69003L	Handle "HICURA", size L, ratchet

Babcock Forceps

Widest inner lumen of all 5 mm HICURA hand instruments: "paddle" design for maximum grasping performance without damage to tissue (e.g. colon)

Length of jaws: 31 mm



Article Number Description

WA69316M	Jaws insert "HICURA", 5 x 330, Babcock, monopolar
WA69316S	Jaws insert "HICURA", 5 x 250, Babcock, monopolar
WA69316L	Jaws insert "HICURA", 5 x 430, Babcock, monopolar
WA69300M	Shaft "HICURA", 5 x 330, monopolar
WA69300S	Shaft "HICURA", 5 x 250, monopolar
WA69300L	Shaft "HICURA", 5 x 430, monopolar
WA69000M	Handle "HICURA", size M, deactivatable ratchet
WA69000L	Handle "HICURA", size L, deactivatable ratchet
WA69003M	Handle "HICURA", size M, ratchet
WA69003L	Handle "HICURA", size L, ratchet

DeBakey Forceps

Fine toothed jaws design and long jaws allows atraumatic grasping of the bowel and other delicate tissue.

Length of jaws: 35 mm



Article Number	Description
WA69318M	Jaws insert "HICURA", 5 x 330, DeBakey, monopolar
WA69318S	Jaws insert "HICURA", 5 x 250, DeBakey, monopolar
WA69318L	Jaws insert "HICURA", 5 x 430, DeBakey, monopolar
WA69300M	Shaft "HICURA", 5 x 330, monopolar
WA69300S	Shaft "HICURA", 5 x 250, monopolar
WA69300L	Shaft "HICURA", 5 x 430, monopolar
WA69000M	Handle "HICURA", size M, deactivatable ratchet
WA69000L	Handle "HICURA", size L, deactivatable ratchet
WA69003M	Handle "HICURA", size M, ratchet
WA69003L	Handle "HICURA", size L, ratchet

Croce-Olmi Forceps

Allows through a special jaws design the grasping and fixation of the tissue out of the hernia sac and bowel manipulation.

Length of jaws: 29 mm



Article Number	Description
WA69320M	Jaws insert "HICURA", 5 x 330, CroceOlmi, monopolar
WA69320S	Jaws insert "HICURA", 5 x 250, CroceOlmi, monopolar
WA69320L	Jaws insert "HICURA", 5 x 430, CroceOlmi, monopolar
WA69300M	Shaft "HICURA", 5 x 330, monopolar
WA69300S	Shaft "HICURA", 5 x 250, monopolar
WA69300L	Shaft "HICURA", 5 x 430, monopolar
WA69000M	Handle "HICURA", size M, deactivatable ratchet
WA69000L	Handle "HICURA", size L, deactivatable ratchet
WA69003M	Handle "HICURA", size M, ratchet
WA69003L	Handle "HICURA", size L, ratchet

Precision Forceps

Grasping forceps for very precise grasping performance

Length of jaws: 24 mm



Article Number	Description
WA69322M	Jaws insert "HICURA", 5 x 330, Precision, monopolar
WA69300M	Shaft "HICURA", 5 x 330, monopolar
WA69000M	Handle "HICURA", size M, deactivatable ratchet
WA69000L	Handle "HICURA", size L, deactivatable ratchet
WA69001M	Handle "HICURA", size M, monopolar
WA69001L	Handle "HICURA", size L, monopolar
WA69003M	Handle "HICURA", size M, ratchet
WA69003L	Handle "HICURA", size L, ratchet

Long Precision Forceps

Longer branch lengths improve overview and handling.

Length of jaws: 36 mm



Article Number	Description
WA69324M	Jaws insert "HICURA", 5 x 330, long Precision, monopolar
WA69300M	Shaft "HICURA", 5 x 330, monopolar
WA69000M	Handle "HICURA", size M, deactivatable ratchet
WA69000L	Handle "HICURA", size L, deactivatable ratchet
WA69001M	Handle "HICURA", size M, monopolar
WA69001L	Handle "HICURA", size L, monopolar
WA69003M	Handle "HICURA", size M, ratchet
WA69003L	Handle "HICURA", size L, ratchet

5 mm HICURA Grasping Forceps

Forceps with Lumen

Good atraumatic grip due to inner lumen and short overall length.
The lumen creates a tweezer effect.
Useful in endometriosis treatment.

Length of jaws: 16 mm



Article Number Description

WA69330M	Jaws insert "HICURA", 5 x 330, with lumen, monopolar
WA69330S	Jaws insert "HICURA", 5 x 250, with lumen, monopolar
WA69330L	Jaws insert "HICURA", 5 x 430, with lumen, monopolar
WA69300M	Shaft "HICURA", 5 x 330, monopolar
WA69300S	Shaft "HICURA", 5 x 250, monopolar
WA69300L	Shaft "HICURA", 5 x 430, monopolar
WA69000M	Handle "HICURA", size M, deactivatable ratchet
WA69000L	Handle "HICURA", size L, deactivatable ratchet
WA69003M	Handle "HICURA", size M, ratchet
WA69003L	Handle "HICURA", size L, ratchet

Clinching Forceps

Allows atraumatic firm grasping of the gall bladder and other slippery tissue through its special jaw design.
Mandatory for cholecystectomy.

Length of jaws: 26 mm



Article Number Description

WA69332M	Jaws insert "HICURA", 5 x 330, Clinching, monopolar
WA69332S	Jaws insert "HICURA", 5 x 250, Clinching, monopolar
WA69332L	Jaws insert "HICURA", 5 x 430, Clinching, monopolar
WA69300M	Shaft "HICURA", 5 x 330, monopolar
WA69300S	Shaft "HICURA", 5 x 250, monopolar
WA69300L	Shaft "HICURA", 5 x 430, monopolar
WA69000M	Handle "HICURA", size M, deactivatable ratchet
WA69000L	Handle "HICURA", size L, deactivatable ratchet
WA69003M	Handle "HICURA", size M, ratchet
WA69003L	Handle "HICURA", size L, ratchet

Wave Type Grasping Forceps

Dedicated grasping forceps for bowel and fragile tissue.

Length of jaws: 30 mm



Article Number Description

WA69334M	Jaws insert "HICURA", 5 x 330, wave type, monopolar
WA69334S	Jaws insert "HICURA", 5 x 250, wave type, monopolar
WA69334L	Jaws insert "HICURA", 5 x 430, wave type, monopolar
WA69300M	Shaft "HICURA", 5 x 330, monopolar
WA69300S	Shaft "HICURA", 5 x 250, monopolar
WA69300L	Shaft "HICURA", 5 x 430, monopolar
WA69000M	Handle "HICURA", size M, deactivatable ratchet
WA69000L	Handle "HICURA", size L, deactivatable ratchet
WA69003M	Handle "HICURA", size M, ratchet
WA69003L	Handle "HICURA", size L, ratchet

Atraumatic Forceps

Multipurpose grasping forceps for all laparoscopic applications.

Length of jaws: 16 mm

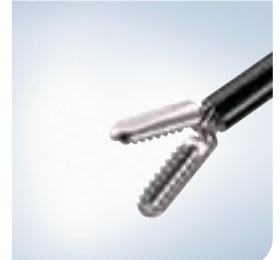

Article Number Description

WA69336M	Jaws insert "HICURA", 5 x 330, atraumatic, monopolar
WA69336S	Jaws insert "HICURA", 5 x 250, atraumatic, monopolar
WA69336L	Jaws insert "HICURA", 5 x 430, atraumatic, monopolar
WA69300M	Shaft "HICURA", 5 x 330, monopolar
WA69300S	Shaft "HICURA", 5 x 250, monopolar
WA69300L	Shaft "HICURA", 5 x 430, monopolar
WA69000M	Handle "HICURA", size M, deactivatable ratchet
WA69000L	Handle "HICURA", size L, deactivatable ratchet
WA69003M	Handle "HICURA", size M, ratchet
WA69003L	Handle "HICURA", size L, ratchet

Flat Forceps

Multipurpose fenestrated grasping forceps for all laparoscopic applications.

Length of jaws: 19 mm



Article Number Description

WA69338M	Jaws insert "HICURA", 5 x 330, flat, monopolar
WA69338S	Jaws insert "HICURA", 5 x 250, flat, monopolar
WA69338L	Jaws insert "HICURA", 5 x 430, flat, monopolar
WA69300M	Shaft "HICURA", 5 x 330, monopolar
WA69300S	Shaft "HICURA", 5 x 250, monopolar
WA69300L	Shaft "HICURA", 5 x 430, monopolar
WA69000M	Handle "HICURA", size M, deactivatable ratchet
WA69000L	Handle "HICURA", size L, deactivatable ratchet
WA69003M	Handle "HICURA", size M, ratchet
WA69003L	Handle "HICURA", size L, ratchet

Forceps with Big Lumen

Atraumatic grasping forceps for delicate tissue manipulation (e.g. bowel, tubes).

Length of jaws: 21 mm

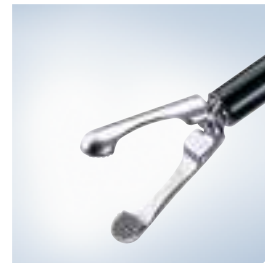

Article Number Description

WA69340M	Jaws insert "HICURA", 5 x 330, with big lumen, monopolar
WA69340S	Jaws insert "HICURA", 5 x 250, with big lumen, monopolar
WA69340L	Jaws insert "HICURA", 5 x 430, with big lumen, monopolar
WA69300M	Shaft "HICURA", 5 x 330, monopolar
WA69300S	Shaft "HICURA", 5 x 250, monopolar
WA69300L	Shaft "HICURA", 5 x 430, monopolar
WA69000M	Handle "HICURA", size M, deactivatable ratchet
WA69000L	Handle "HICURA", size L, deactivatable ratchet
WA69003M	Handle "HICURA", size M, ratchet
WA69003L	Handle "HICURA", size L, ratchet

Manhes Forceps

Precise fixation and manipulation of fragile tissue

Length of jaws: 18 mm



Article Number Description

WA69342M	Jaws insert "HICURA", 5 x 330, Manhes, monopolar
WA69342S	Jaws insert "HICURA", 5 x 250, Manhes, monopolar
WA69342L	Jaws insert "HICURA", 5 x 430, Manhes, monopolar
WA69300M	Shaft "HICURA", 5 x 330, monopolar
WA69300S	Shaft "HICURA", 5 x 250, monopolar
WA69300L	Shaft "HICURA", 5 x 430, monopolar
WA69000M	Handle "HICURA", size M, deactivatable ratchet
WA69000L	Handle "HICURA", size L, deactivatable ratchet
WA69003M	Handle "HICURA", size M, ratchet
WA69003L	Handle "HICURA", size L, ratchet

Claw Type Forceps

For recovery of e.g. gall bladder, Myoma, etc

Length of jaws: 28 mm



Article Number Description

WA69344M	Jaws insert "HICURA", 5 x 330, claw type, monopolar
WA69344S	Jaws insert "HICURA", 5 x 250, claw type, monopolar
WA69344L	Jaws insert "HICURA", 5 x 430, claw type, monopolar
WA69300M	Shaft "HICURA", 5 x 330, monopolar
WA69300S	Shaft "HICURA", 5 x 250, monopolar
WA69300L	Shaft "HICURA", 5 x 430, monopolar
WA69000M	Handle "HICURA", size M, deactivatable ratchet
WA69000L	Handle "HICURA", size L, deactivatable ratchet
WA69003M	Handle "HICURA", size M, ratchet
WA69003L	Handle "HICURA", size L, ratchet

5 mm HICURA Grasping Forceps

Crocodile Type Forceps

For strong and tight fixation of tissue
(e.g. stomach, gall bladder)

Length of jaws: 18 mm



Article Number	Description
WA69346M	Jaws insert "HICURA", 5 x 330, crocodile type, monopolar
WA69346S	Jaws insert "HICURA", 5 x 250, crocodile type, monopolar
WA69346L	Jaws insert "HICURA", 5 x 430, crocodile type, monopolar
WA69300M	Shaft "HICURA", 5 x 330, monopolar
WA69300S	Shaft "HICURA", 5 x 250, monopolar
WA69300L	Shaft "HICURA", 5 x 430, monopolar
WA69000M	Handle "HICURA", size M, deactivatable ratchet
WA69000L	Handle "HICURA", size L, deactivatable ratchet
WA69003M	Handle "HICURA", size M, ratchet
WA69003L	Handle "HICURA", size L, ratchet

Flat jaw insert for thoracic surgery

For atraumatic manipulation of tissue

Length of jaws: 14 mm

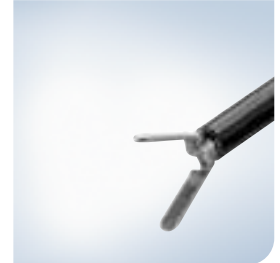

Article Number	Description
WA69326S	Jaws insert "HICURA", 5 x 250, flat, for thoracic surgery, monopolar
WA69300S	Shaft "HICURA", 5 x 250, monopolar
WA69000M	Handle "HICURA", size M, deactivatable ratchet
WA69000L	Handle "HICURA", size L, deactivatable ratchet
WA69001M	Handle "HICURA", size M, monopolar
WA69001L	Handle "HICURA", size L, monopolar
WA69003M	Handle "HICURA", size M, ratchet
WA69003L	Handle "HICURA", size L, ratchet

Flat jaw insert for thoracic surgery

Length of jaws: 16 mm



Article Number	Description
WA69328S	Jaws insert "HICURA", 5 x 250, for thoracic surgery, monopolar
WA69300S	Shaft "HICURA", 5 x 250, monopolar
WA69000M	Handle "HICURA", size M, deactivatable ratchet
WA69000L	Handle "HICURA", size L, deactivatable ratchet
WA69001M	Handle "HICURA", size M, monopolar
WA69001L	Handle "HICURA", size L, monopolar
WA69003M	Handle "HICURA", size M, ratchet
WA69003L	Handle "HICURA", size L, ratchet

5 mm HICURA Dissection Forceps

Maryland Forceps

Multipurpose curved dissection forceps with cross-cut surface for strong grasping for all laparoscopic applications.

Length of jaws: 17 mm



Article Number	Description
WA69350M	Jaws insert "HICURA", 5 x 330, Maryland, monopolar
WA69350S	Jaws insert "HICURA", 5 x 250, Maryland, monopolar
WA69350L	Jaws insert "HICURA", 5 x 430, Maryland, monopolar
WA69300M	Shaft "HICURA", 5 x 330, monopolar
WA69300S	Shaft "HICURA", 5 x 250, monopolar
WA69300L	Shaft "HICURA", 5 x 430, monopolar
WA69001M	Handle "HICURA", size M, monopolar
WA69001L	Handle "HICURA", size L, monopolar

Precision Forceps

For very precise dissection.

Length of jaws: 25 mm



Article Number	Description
WA69354M	Jaws insert "HICURA", 5 x 330, precision, monopolar
WA69300M	Shaft "HICURA", 5 x 330, monopolar
WA69001M	Handle "HICURA", size M, monopolar
WA69001L	Handle "HICURA", size L, monopolar

Long Maryland Forceps

Longer branch length improves overview and handling.

Length of jaws: 21 mm



Article Number	Description
WA69352M	Jaws insert "HICURA", 5 x 330, Maryland long, monopolar
WA69352S	Jaws insert "HICURA", 5 x 250, Maryland long, monopolar
WA69352L	Jaws insert "HICURA", 5 x 430, Maryland long, monopolar
WA69300M	Shaft "HICURA", 5 x 330, monopolar
WA69300S	Shaft "HICURA", 5 x 250, monopolar
WA69300L	Shaft "HICURA", 5 x 430, monopolar
WA69001M	Handle "HICURA", size M, monopolar
WA69001L	Handle "HICURA", size L, monopolar

Maryland Straight Forceps

For delicate dissection and needle holder assistance.

Length of jaws: 15 mm



Article Number	Description
WA69356M	Jaws insert "HICURA", 5 x 330, Maryland straight, monopolar
WA69356S	Jaws insert "HICURA", 5 x 250, Maryland straight, monopolar
WA69356L	Jaws insert "HICURA", 5 x 430, Maryland straight, monopolar
WA69300M	Shaft "HICURA", 5 x 330, monopolar
WA69300S	Shaft "HICURA", 5 x 250, monopolar
WA69300L	Shaft "HICURA", 5 x 430, monopolar
WA69001M	Handle "HICURA", size M, monopolar
WA69001L	Handle "HICURA", size L, monopolar

5 mm HICURA Dissection Forceps

Precision Forceps

For very precise dissection.

Length of jaws: 25 mm



Article Number	Description
WA69354M	Jaws insert "HICURA", 5 x 330, precision, monopolar
WA69300M	Shaft "HICURA", 5 x 330, monopolar
WA69001M	Handle "HICURA", size M, monopolar
WA69001L	Handle "HICURA", size L, monopolar

Tear Drop Forceps

Length of jaws: 21 mm



Article Number	Description
WA69362M	Jaws insert "HICURA", 5 x 330, Tear drop forceps, monopolar
WA69300M	Shaft "HICURA", 5 x 330, monopolar
WA69000L	Handle "HICURA", size L, deactivatable ratchet
WA69000M	Handle "HICURA", size M, deactivatable ratchet
WA69001L	Handle "HICURA", size L, monopolar
WA69001M	Handle "HICURA", size M, monopolar
WA69003L	Handle "HICURA", size L, ratchet
WA69003M	Handle "HICURA", size M, ratchet

Maryland 90° Angled Forceps

For blood vessel dissection.

Length of jaws: 18 mm



Article Number	Description
WA69358M	Jaws insert "HICURA", 5 x 330, Maryland 90° angled, monopolar
WA69358S	Jaws insert "HICURA", 5 x 250, Maryland 90° angled, monopolar
WA69358L	Jaws insert "HICURA", 5 x 430, Maryland 90° angled, monopolar
WA69300M	Shaft "HICURA", 5 x 330, monopolar
WA69300S	Shaft "HICURA", 5 x 250, monopolar
WA69300L	Shaft "HICURA", 5 x 430, monopolar
WA69001M	Handle "HICURA", size M, monopolar
WA69001L	Handle "HICURA", size L, monopolar

5 mm HICURA Monopolar Scissors

Metzenbaum Scissors

Multipurpose scissors for all laparoscopic applications.

Length of jaws: 19 mm



Article Number Description

WA69370M	Jaws insert "HICURA", 5 x 330, Metzenbaum, monopolar
WA69370S	Jaws insert "HICURA", 5 x 250, Metzenbaum, monopolar
WA69370L	Jaws insert "HICURA", 5 x 430, Metzenbaum, monopolar
WA69300M	Shaft "HICURA", 5 x 330, monopolar
WA69300S	Shaft "HICURA", 5 x 250, monopolar
WA69300L	Shaft "HICURA", 5 x 430, monopolar
WA69001M	Handle "HICURA", size M, monopolar
WA69001L	Handle "HICURA", size L, monopolar

Mini Metzenbaum Scissors

For precise cutting and preparation.

Length of jaws: 16 mm



Article Number Description

WA69372M	Jaws insert "HICURA", 5 x 330, Metzenbaum mini, monopolar
WA69372S	Jaws insert "HICURA", 5 x 250, Metzenbaum mini, monopolar
WA69372L	Jaws insert "HICURA", 5 x 430, Metzenbaum mini, monopolar
WA69300M	Shaft "HICURA", 5 x 330, monopolar
WA69300S	Shaft "HICURA", 5 x 250, monopolar
WA69300L	Shaft "HICURA", 5 x 430, monopolar
WA69001M	Handle "HICURA", size M, monopolar
WA69001L	Handle "HICURA", size L, monopolar

Straight Scissors

For precise cutting and preparation.

Length of jaws: 19 mm



Article Number Description

WA69374M	Jaws insert "HICURA", 5 x 330, straight, monopolar
WA69374S	Jaws insert "HICURA", 5 x 250, straight, monopolar
WA69374L	Jaws insert "HICURA", 5 x 430, straight, monopolar
WA69300M	Shaft "HICURA", 5 x 330, monopolar
WA69300S	Shaft "HICURA", 5 x 250, monopolar
WA69300L	Shaft "HICURA", 5 x 430, monopolar
WA69001M	Handle "HICURA", size M, monopolar
WA69001L	Handle "HICURA", size L, monopolar

Hook Scissors

For cutting sutures.

Length of jaws: 12 mm



Article Number Description

WA69376M	Jaws insert "HICURA", 5 x 330, hook, monopolar
WA69376S	Jaws insert "HICURA", 5 x 250, hook, monopolar
WA69376L	Jaws insert "HICURA", 5 x 430, hook, monopolar
WA69300M	Shaft "HICURA", 5 x 330, monopolar
WA69300S	Shaft "HICURA", 5 x 250, monopolar
WA69300L	Shaft "HICURA", 5 x 430, monopolar
WA69001M	Handle "HICURA", size M, monopolar
WA69001L	Handle "HICURA", size L, monopolar

Precision Scissors

For cutting sutures.

Length of jaws: 12 mm



Article Number Description

WA69378M	Jaws insert "HICURA", 5 x 330, Precision Scissors, monopolar
WA69300M	Shaft "HICURA", 5 x 330, monopolar
WA69001L	Handle "HICURA", size L, monopolar
WA69001M	Handle "HICURA", size M, monopolar

5 mm HICURA Knot Pusher and Assistant Needle Holder

HICURA Knot Pusher

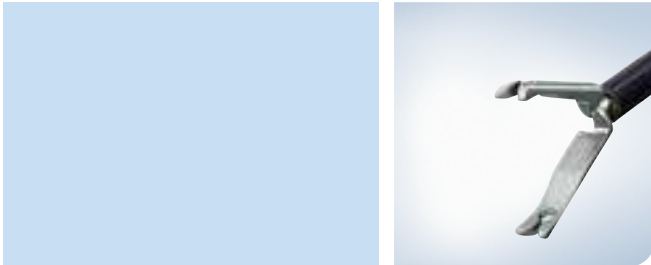

Article Number Description

WA69380M	Jaws insert "HICURA", 5 x 330, knot pusher
WA69300M	Shaft "HICURA", 5 x 330, monopolar
WA69000M	Handle "HICURA", size M, deactivatable ratchet
WA69000L	Handle "HICURA", size L, deactivatable ratchet
WA69001M	Handle "HICURA", size M, monopolar
WA69001L	Handle "HICURA", size L, monopolar
WA69003M	Handle "HICURA", size M, ratchet
WA69003L	Handle "HICURA", size L, ratchet

HICURA Assistant Needle Holder

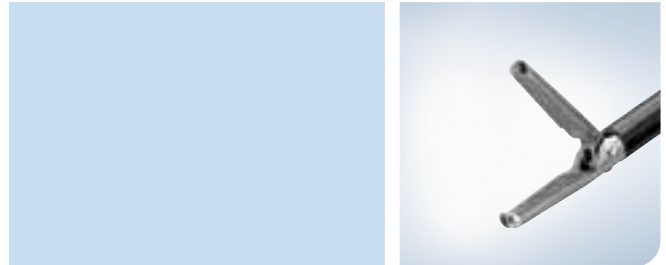

Article Number Description

WA69384S	Jaws insert "HICURA", 5 x 250, assistant needle holder
WA69384M	Jaws insert "HICURA", 5 x 330, assistant needle holder
WA69384L	Jaws insert "HICURA", 5 x 430, assistant needle holder
WA69300S	Shaft "HICURA", 5 x 250, monopolar
WA69300M	Shaft "HICURA", 5 x 330, monopolar
WA69300L	Shaft "HICURA", 5 x 430, monopolar
WA69000M	Handle "HICURA", size M, deactivatable ratchet
WA69000L	Handle "HICURA", size L, deactivatable ratchet
WA69001M	Handle "HICURA", size M, monopolar
WA69001L	Handle "HICURA", size L, monopolar
WA69003M	Handle "HICURA", size M, ratchet
WA69003L	Handle "HICURA", size L, ratchet

HICURA Roeder Knot Pusher

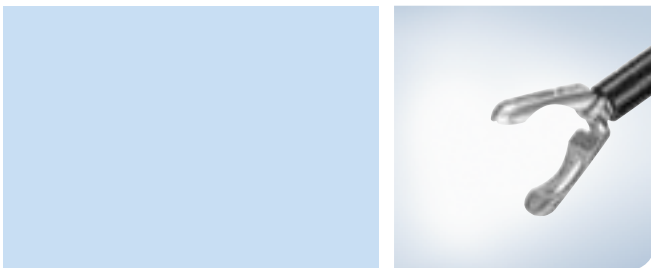

Article Number Description

WA69382M	Jaws insert "HICURA", 5 x 330, Roeder
WA69300M	Shaft "HICURA", 5 x 330, monopolar
WA69000M	Handle "HICURA", size M, deactivatable ratchet
WA69000L	Handle "HICURA", size L, deactivatable ratchet
WA69001M	Handle "HICURA", size M, monopolar
WA69001L	Handle "HICURA", size L, monopolar
WA69003M	Handle "HICURA", size M, ratchet
WA69003L	Handle "HICURA", size L, ratchet

5 mm HICURA Biopsy Forceps

Biopsy Forceps with Spike

Length of jaws: 14 mm



Article Number Description

WA69390M	Jaws insert "HICURA", 5 x 330, with spike, monopolar
WA69390L	Jaws insert "HICURA", 5 x 430, with spike, monopolar
WA69300M	Shaft "HICURA", 5 x 330, monopolar
WA69300L	Shaft "HICURA", 5 x 430, monopolar
WA69000M	Handle "HICURA", size M, deactivatable ratchet
WA69000L	Handle "HICURA", size L, deactivatable ratchet
WA69001M	Handle "HICURA", size M, monopolar
WA69001L	Handle "HICURA", size L, monopolar
WA69003M	Handle "HICURA", size M, ratchet
WA69003L	Handle "HICURA", size L, ratchet

Severing Biopsy Forceps

Length of jaws: 12 mm



Article Number Description

WA69392M	Jaws insert "HICURA", 5 x 330, severing, monopolar
WA69392L	Jaws insert "HICURA", 5 x 430, severing, monopolar
WA69300M	Shaft "HICURA", 5 x 330, monopolar
WA69300L	Shaft "HICURA", 5 x 430, monopolar
WA69000M	Handle "HICURA", size M, deactivatable ratchet
WA69000L	Handle "HICURA", size L, deactivatable ratchet
WA69001M	Handle "HICURA", size M, monopolar
WA69001L	Handle "HICURA", size L, monopolar
WA69003M	Handle "HICURA", size M, ratchet
WA69003L	Handle "HICURA", size L, ratchet

5 mm HICURA Bipolar Grasping Forceps

Johann Forceps

Multipurpose grasping forceps for strong grasping and atraumatic dissection for all laparoscopic procedures.

Length of jaws: 17 mm



Article Number	Description
WA69410M	Jaws insert "HICURA", 5 x 330, Johann, bipolar
WA69400M	Shaft "HICURA", 5 x 330, bipolar
WA69002M	Handle "HICURA", size M, bipolar
WA69002L	Handle "HICURA", size L, bipolar

Manhes Forceps

Grasping forceps for myomectomy and cystectomy

Length of jaws: 14 mm



Article Number	Description
WA69414M	Jaws insert "HICURA", 5 x 330, Manhes, bipolar
WA69400M	Shaft "HICURA", 5 x 330, bipolar
WA69002M	Handle "HICURA", size M, bipolar
WA69002L	Handle "HICURA", size L, bipolar

Hirsch Forceps

For tubal sterilization and endometriosis treatment.

Length of jaws: 20 mm



Article Number	Description
WA69412M	Jaws insert "HICURA", 5 x 330, Hirsch, bipolar
WA69400M	Shaft "HICURA", 5 x 330, bipolar
WA69002M	Handle "HICURA", size M, bipolar
WA69002L	Handle "HICURA", size L, bipolar

Precision Forceps

Length of jaws: 24 mm



Article Number	Description
WA69424M	Jaws insert "HICURA", 5 x 330, Precision Forceps, bipolar
WA69400M	Shaft "HICURA", 5 x 330, bipolar
WA69002L	Handle "HICURA", size L, bipolar
WA69002M	Handle "HICURA", size M, bipolar

5 mm HICURA Bipolar Dissection Forceps

Maryland Forceps

Multipurpose curved dissection forceps for all laparoscopic procedures.

Length of jaws: 15 mm



Article Number	Description
WA69416M	Jaws insert "HICURA", 5 x 330, Maryland, bipolar
WA69400M	Shaft "HICURA", 5 x 330, bipolar
WA69002M	Handle "HICURA", size M, bipolar
WA69002L	Handle "HICURA", size L, bipolar

Straight Forceps

Multipurpose straight dissection forceps for all laparoscopic procedures.

Length of jaws: 13 mm



Article Number	Description
WA69420M	Jaws insert "HICURA", 5 x 330, straight, bipolar
WA69400M	Shaft "HICURA", 5 x 330, bipolar
WA69002M	Handle "HICURA", size M, bipolar
WA69002L	Handle "HICURA", size L, bipolar

Fine Maryland Forceps

Improved overview and handling due to increased branch length.

Length of jaws: 19 mm



Article Number	Description
WA69418M	Jaws insert "HICURA", 5 x 330, Maryland fine, bipolar
WA69400M	Shaft "HICURA", 5 x 330, bipolar
WA69002M	Handle "HICURA", size M, bipolar
WA69002L	Handle "HICURA", size L, bipolar

Tweezers Forceps

For very delicate dissection and coagulation

Length of jaws: 17 mm



Article Number	Description
WA69422M	Jaws insert "HICURA", 5 x 330, tweezers, bipolar
WA69400M	Shaft "HICURA", 5 x 330, bipolar
WA69002M	Handle "HICURA", size M, bipolar
WA69002L	Handle "HICURA", size L, bipolar

Modular Spare Parts for 5 mm HICURA Instruments

HICURA Monopolar/Nonpolar Handles

Handle "HICURA",
deactivatable ratchet,



Article Number Description

WA69000M	size M
WA69000L	size L

Handle "HICURA",
monopolar,



Article Number Description

WA69001M	size M
WA69001L	size L

Handle "HICURA",
ratchet,



Article Number Description

WA69003M	size M
WA69003L	size L

HICURA Bipolar Handle

Handle "HICURA",
bipolar,



Article Number Description

WA69002M	size M
WA69002L	size L

HICURA Monopolar Shafts

Article Number Description

WA69300S	Shaft "HICURA", 5 x 250, monopolar
-----------------	------------------------------------

Article Number Description

WA69300M	Shaft "HICURA", 5 x 330, monopolar
-----------------	------------------------------------

Article Number Description

WA69300L	Shaft "HICURA", 5 x 430, monopolar
-----------------	------------------------------------

Monopolar HF Cables

HF cable, monopolar, 3.5 m length,

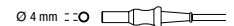

Article Number Description

A0355	Valleylab (old)
A0357	ESG 400, ESG 410, Erbe T series, Berchtold
A0358	ESG 400, ESG410, Valleylab (new)

HICURA Bipolar Shaft

Article Number Description

WA69400M	Shaft, 5 x 330 mm
-----------------	-------------------

Bipolar HF Cable

HF cable, bipolar, 3.5 m length,



Article Number Description

A60000C	ESG 400, ESG 410, HF-300, Erbe HF units* (*depending on individual connector configuration)
A60001C	ESG 410, Erbe International HF units
A60002C	Martin HF unit
A60003C	ESG 400, ESG 410, Erbe VIO*, Valleylab HF units

HICURA System Charts

HICURA Monopolar System Chart

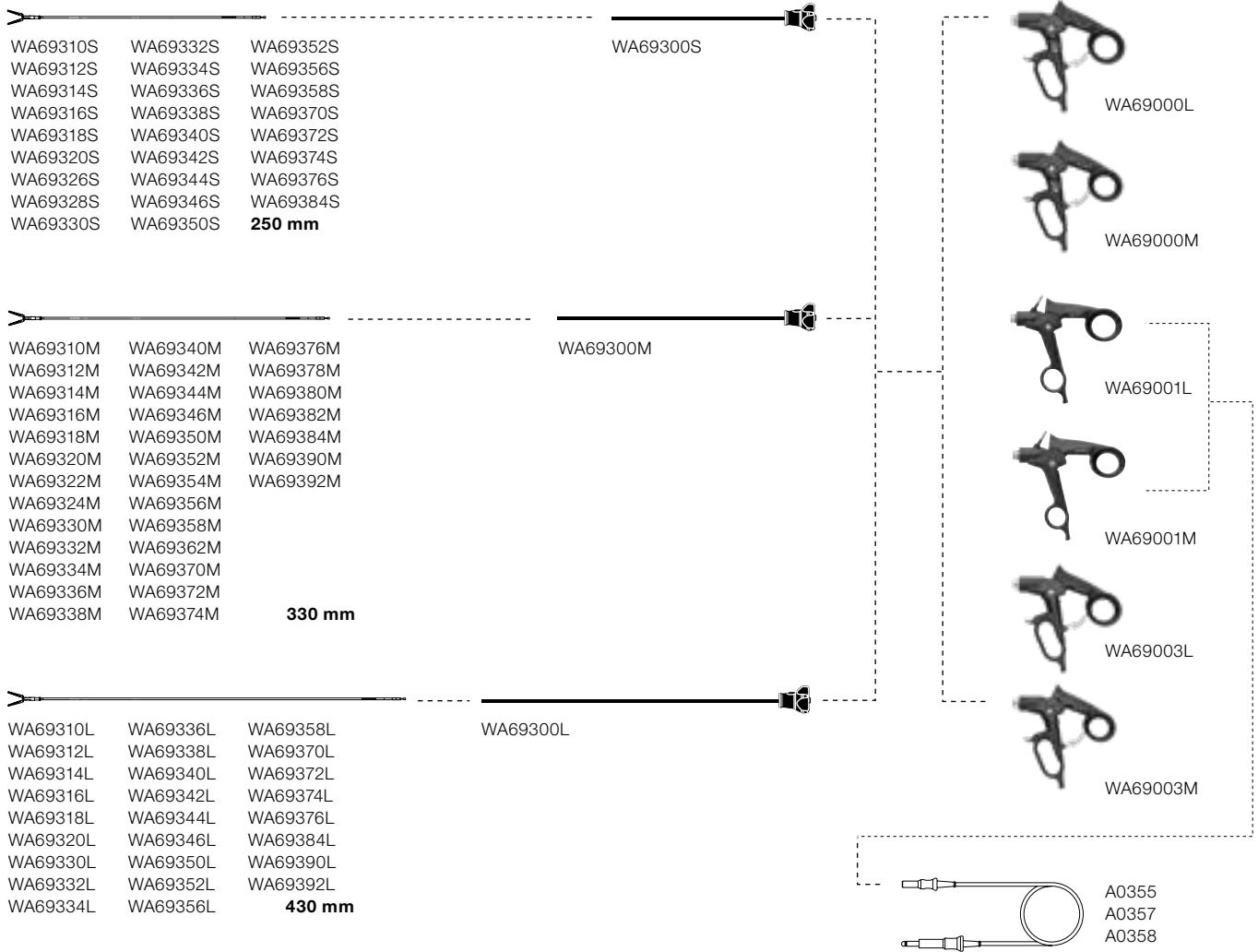

HICURA Bipolar System Chart

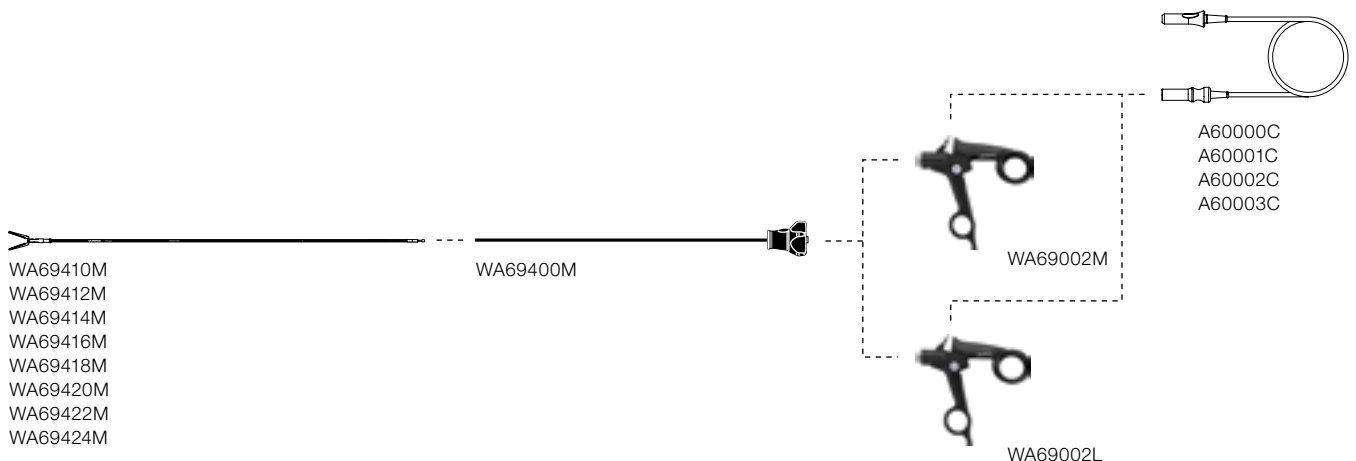

10 mm HiQ+ Instruments

Claw Forceps

For recoverage of e.g. gall bladder, myoma, etc.

Length of jaws: 45 mm



Article Number	Description
A66020A	Jaws insert, 330 mm working length
A60900A	Shaft, 330 mm working length
A60100A	Handle "Ergo", ratchet
A60200A	Handle "Ergo S", ratchet

Short Maryland Forceps

For precise dissection and needle holder assistance.

Length of jaws: 24 mm



Article Number	Description
A66320A	Jaws insert, 330 mm working length
A60900A	Shaft, 330 mm working length
A60100A	Handle "Ergo", ratchet
A60200A	Handle "Ergo S", ratchet

Maryland Forceps

Multipurpose curved dissection forceps for all laparoscopic applications

Length of jaws: 30 mm



Article Number	Description
A66310A	Jaws insert, 330 mm working length
A60901A	Shaft, 330 mm working length
A60101A	Handle "Ergo", ratchet
A60201A	Handle "Ergo S", ratchet

Babcock Forceps (Atraumatic)

Widest inner lumen of all 10 mm
HiQ+ hand instruments: "paddle"
design for maximum grasping
performance without damage to soft
tissue (e.g. colon)

Length of jaws: 53 mm



Article Number	Description
WA66040A	Jaws insert, 330 mm working length
A60900A	Shaft, 330 mm working length
A60100A	Handle "Ergo", ratchet
A60200A	Handle "Ergo S", ratchet

Babcock Forceps

For manipulation of large fragile
tissue (e.g. bowel, stomach, etc.)

Length of jaws: 47 mm



Article Number	Description
A66050A	Jaws insert, 330 mm working length
A60900A	Shaft, 330 mm working length
A60100A	Handle "Ergo", ratchet
A60200A	Handle "Ergo S", ratchet

Atraumatic Grasping Forceps

Dedicated grasping forceps for
bowel and fragile tissue

Length of jaws: 42 mm



Article Number	Description
A66060A	Jaws insert, 330 mm working length
A60900A	Shaft, 330 mm working length
A60100A	Handle "Ergo", ratchet
A60200A	Handle "Ergo S", ratchet

CBD Grasping Forceps

Soft-layered grasping forceps
dedicated for manipulation
of fragile tissue
and flexible telescopes.

Length of jaws: 16 mm



Article Number	Description
A66070A	Jaws insert, 330 mm working length
A60901A	Shaft, 330 mm working length
A60100A	Handle "Ergo", ratchet
A60200A	Handle "Ergo S", ratchet



HiQ+ Spare Parts for 10 mm Instruments

HiQ+ Ergo Handles



Article Number Description

A60100A Handle "HiQ+", Ergo, ratchet



Article Number Description

A60101A Handle "HiQ+", Ergo, monopolar



Article Number Description

A60200A Handle "HiQ+", Ergo, ratchet, monopolar



Article Number Description

A60201A Handle "Ergo S", monopolar, with silicone finger ring

10 mm HiQ+ Shafts



Article Number Description

A60900A Shaft "HiQ+" 10 x 330 mm, A60901A insulated



Article Number Description

A60901A Shaft "HiQ+" 10 x 330 mm, insulated, tapered

Spare Parts

Article Number Description

A0389 Finger ring, silicone, for HiQ+ S handles 

A03440A Sealing cap, 2.2 mm, 10 pcs. 

A03441A Spare button, for shaft, 10 pcs. 

A03442A Spare sealing ring "HiQ+", for shaft, 20 pcs. 

HF cable, monopolar, 3.5 m length,

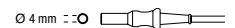

Article Number Description

A0355 Valleylab (old)

A0357 ESG 400, ESG 410, Erbe T series, Berchtold

A0358 ESG 400, ESG410, Valleylab (new)

System Chart

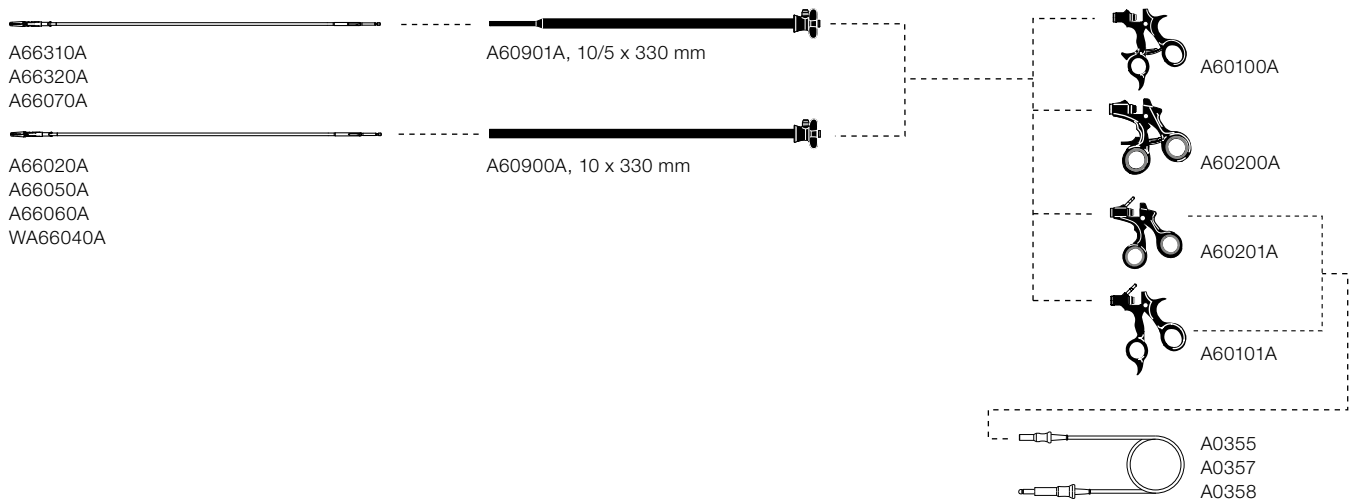



5 mm HiQ+ HF Electrodes

5 mm HiQ+ Shafts

Article Number Description

A6280	HF electrode, button, 5 x 330 mm	
--------------	----------------------------------	---

A6281	HF electrode, needle, 5 x 330 mm	
--------------	----------------------------------	---

A6282	HF electrode, hook, 5 x 330 mm	
--------------	--------------------------------	---

A6292	HF electrode, hook, with suction channel, 5 x 330 mm	
--------------	--	--

A6283 A6289	HF electrode, hook long, 5 x 330 mm 5 x 400 mm	
------------------------------	---	---

A6293 A6299	HF electrode, hook long, with suction channel, 5 x 330 mm 5 x 400 mm	
------------------------------	---	---

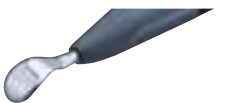
A6284	HF electrode, spoon, 5 x 330 mm	
--------------	---------------------------------	---

A6294	HF electrode, spoon, with suction channel, 5 x 330 mm	
--------------	---	---

Monopolar HF Electrodes

HF cable, monopolar, 3.5 m length,

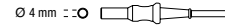

Article Number Description

A0355	Valleylab (old)
A0357	ESG 400, ESG 410, Erbe T series, Berchtold
A0358	ESG 400, ESG410, Valleylab (new)

HiQ+ Suction and Irrigation

Standard Suction/Irrigation System	
Article Number	Description
WA51111A WA51131A WA51131L	Suction/irrigation tube, distal holes, for HiQ+ handle, 3.3 x 360 mm 5.3 x 360 mm 5.3 x 450 mm
WA51132A	Suction/irrigation tube, 1.5 x 360 mm, for aspiration, for HiQ+ handle
WA51138A	Suction/irrigation tube, 5 x 360 mm, button, monopolar, for HiQ+ handle
WA51172A	Handle "HiQ+", for suction/irrigation tube, valve
WA51181S	Valve tubing (spare), for HiQ+ handle, suction channel 5 mm, 1 pc.

Large Diameter Suction/Irrigation System	
Article Number	Description
WA51151A WA51151L	Suction/irrigation tube, distal holes, for HiQ+ handle, 10 x 360 mm 10 x 450 mm
WA51172A	Handle "HiQ+", for suction/irrigation tube, valve
WA51181L	Valve tubing (spare), for HiQ+ handle, suction channel 8 mm, 1 pc.

HiQ+ Suction and Irrigation

Standard Suction/Irrigation System

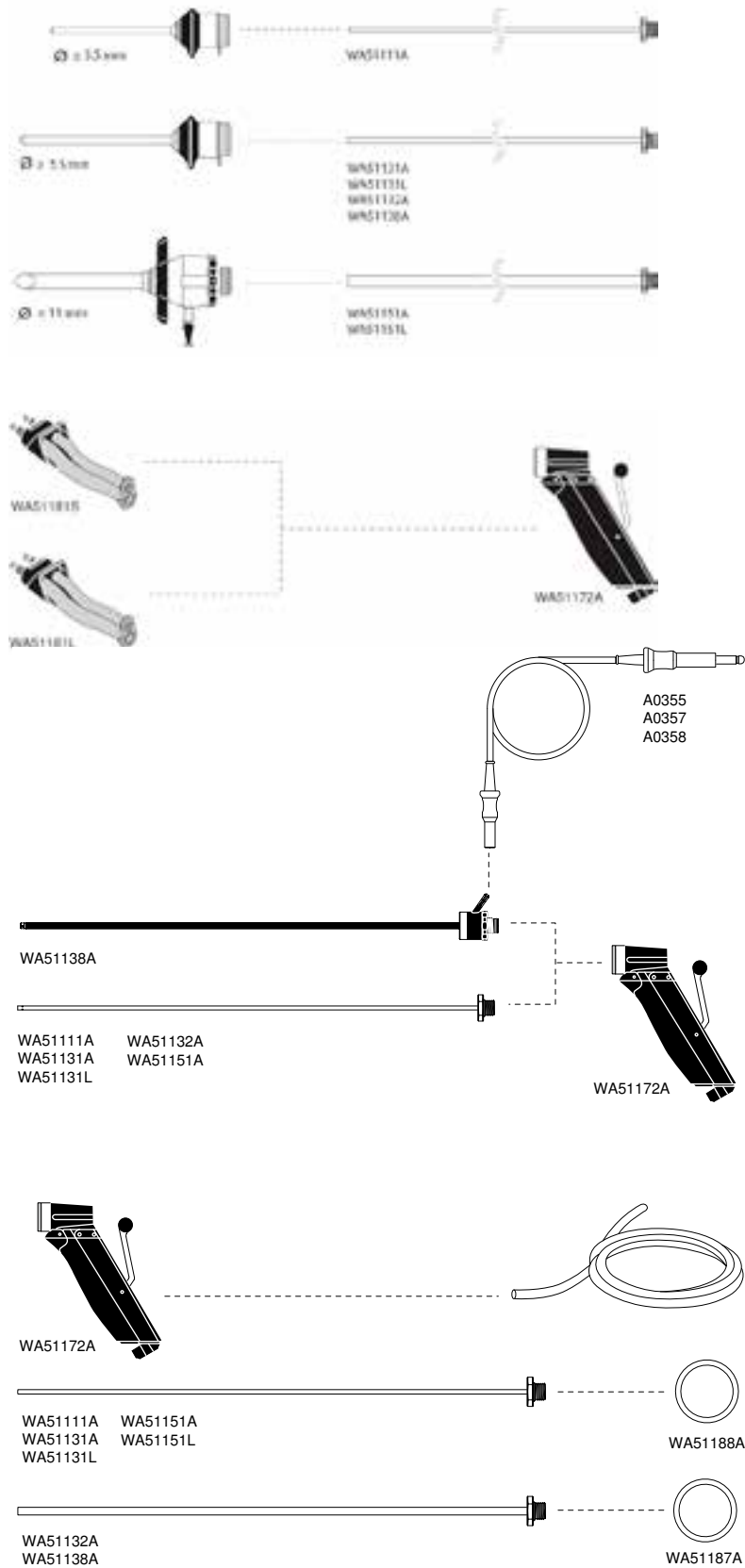

HiQ+ Needle Holder

Straight Needle Holder



Grasping forceps,
needle holder,
straight,
5 mm,



Article Number Description

WA64700A	Jaws insert, 330 mm
WA64700L	Jaws insert, 430 mm
WA60120A	Handle, with sheath, 330 mm, ratchet
WA60120L	Handle, with sheath, 430 mm, ratchet

Left-Curved Needle Holder



Grasping forceps,
needle holder,
left-curved,
5 mm,



Article Number Description

WA64710A	Jaws insert, 330 mm
WA64710L	Jaws insert, 430 mm
WA60120A	Handle, with sheath, 330 mm, ratchet
WA60120L	Handle, with sheath, 430 mm, ratchet

Self-Alignment Needle Holder



Grasping forceps,
needle holder,
self-alignment,
5 mm,



Article Number Description

WA64720A	Jaws insert, 330 mm
WA60120A	Handle, with sheath, 330 mm, ratchet

Dolphin Type Needle Holder



Grasping forceps,
needle holder,
dolphin type,
5 mm,



Article Number Description

WA64730A	Jaws insert, 330 mm
WA60120A	Handle, with sheath, 330 mm, ratchet

Right-Curved Needle Holder

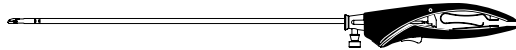

Grasping forceps,
needle holder,
right-curved,
5 mm,



Article Number Description

WA64740A	Jaws insert, 330 mm
WA64740L	Jaws insert, 430 mm
WA60120A	Handle, with sheath, 330 mm, ratchet
WA60120L	Handle, with sheath, 430 mm, ratchet

Assistant Needle Holder

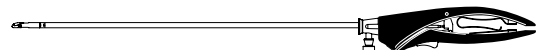

Grasping forceps,
needle holder,
assistant,
5 mm,



Article Number Description

WA64750A	Jaws insert, 330 mm
WA60120A	Handle, with sheath, 330 mm, ratchet

HiQ+ Needle Holder

HiQ+ Inline A Handles

Article Number Description

WA60120A Handle, with sheath, 5 x 330 mm, with ratchet

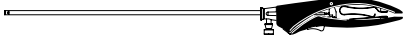

WA60120L Handle, with sheath, 5 x 430 mm, with ratchet



A0400 Sealing cap, blue, for Luer-lock, 6 pcs.

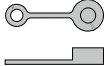

Standard Needle Holders

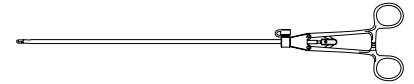

Grasping forceps, needle holder, with self-alignment,



Article Number Description

WA56900A 5 x 300 mm, straight



Grasping forceps, needle holder, with self-alignment,



Article Number Description

A5690 5 x 300 mm, straight

A5698 5 x 300 mm, curved

WA56090L 5 x 390 mm, straight

WA56098L 5 x 390 mm, curved

A0400 Sealing cap, blue, for Luer-lock, 6 pcs.

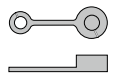

HiQ+ Knot Pusher and Fascial Closure

HiQ+ Roeder Knot Pusher



Article Number	Description
----------------	-------------

WA56903A	Knot pusher, 5 x 330 mm
----------	-------------------------

Fascial Closure

Article Number	Description
----------------	-------------

WA51203A	Needle, for fascial closure, 140 mm
----------	---

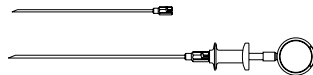

WA51205A	Spare cannula, for WA51203A
----------	--------------------------------

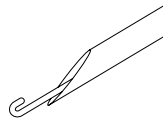

Did you know?

Did you know that Olympus offers comprehensive support in Training, Service and even creates design concepts to achieve the optimal solution to maximized departmental efficiency?

Contact your local Sales Representative for more information!



- Our modular services provide you with a number of advantages compared to standardized service contracts.
- Together with your Olympus partner it is easy to pick the most suitable modules from our flexible service offer to increase efficiency, reduce costs and make medical workflows more reliable.
- Find out more about our variety of combinable service modules and discover the advantages of the Olympus Modular Service Concept.

Service Solutions
Secure your investment



- Olympus offers certified international medical expert training courses.
- Courses are led by medical experts – with the support of Olympus – to help healthcare professionals optimize their skills.
- Our training centers are connected to clinical networks so that live procedures can be broadcast directly from the endosuites and operating theatres of leading institutions for training purposes

Medical Expert Training



- Olympus offers a range of products and services to provide fully integrated healthcare solutions.
- From the design concept through to managing the construction, installation and commissioning, we can help you achieve the optimal solution to maximize departmental efficiency and improve health & safety for both users and patients within your healthcare facility.

ENDOALPHA

HICURA, HiQ+

Specifications, design, and accessories are subject to change without any notice or obligation on the part of the manufacturer.

OLYMPUS

OLYMPUS SURGICAL TECHNOLOGIES EUROPE

Olympus Winter & Ibe GmbH
Kuehnstraße 61
22045 Hamburg, Germany
www.olympus.eu

W7053952_4